

Elcometer PERFORMANCE Blast Machines have been designed to minimise pressure loss and maximise air flow - allowing you to blast for longer, reduce media costs and minimise downtime.

### Rating Plate

Clear information on pressure ratings, UKCA and CE approval to both PED 2014/68EU and PE(s)R 2016.

### Easy Access

Large inspection access wide enough for both arms.

### Fast Flow Cones

45/90° cone to maximise abrasive flow rate.

### Precision Media Valves

Enable finger tip adjustment allowing you to use less abrasive to cover the same area in less time.

### High Flow Dish

Concave dish for easy refill and deflector plate for operator safety.

### Easy to manoeuvre

Balanced design makes it easy to move on site.

### High flow 1½" (38mm) Pipework

1½" (38mm) pipework throughout ensures efficient airflow and minimal pressure loss

### 1½" (38mm) Remote Control Valves

Minimises air flow loss and shuts the blast system down quickly and safely.

### Moisture Separator

Prevents water and oil from entering the blast pot.

### Flexible Pusher Line

Hard wearing flexible pusher line to maximise air flow.



# The Elcometer Abrasive Blast Machine Range Comparison Summary

From small maintenance projects to large scale refurbishment contracts, from blasting small industrial parts to ballast tanks, or iron gates to bridges...

...whatever the scale of your project Elcometer blast equipment is engineered to last longer, work harder and perform better.

## CONTRACTOR

**174psi**  
(12bar)

**1 1/4"**  
(32mm)

- Industry standard valves & RCV
  - 1 1/4" (32mm) pipework
- Great efficiency & productivity
  - 174psi (12bar)



1.41-7.06cu ft (40-200 litres)

174psi (12bar)

32mm (1 1/4")

UKCA & CE Approved

Standard Grit Valve (SGV)

Standard

Elcometer Engineered  
Standard Mixer T

Standard

Elbow

Made in Great Britain

Capacity

Maximum Working Pressure (WP)

Pipework Diameter

UKCA & CE Approved to  
PED 2014/68EU & PE(s)R 2016

Abrasive Media Valve

Valve Liner

Mixer T

Remote Control Valve

Exhaust T

Construction

# PERFORMANCE

**174psi**  
(12bar)

**1 1/4"**  
(32mm)

- Elcometer engineered valves & RCV
  - 1 1/2" (38mm) high flow pipework
  - High efficiency & productivity
    - 174psi (12bar)
  - Ideal for all projects

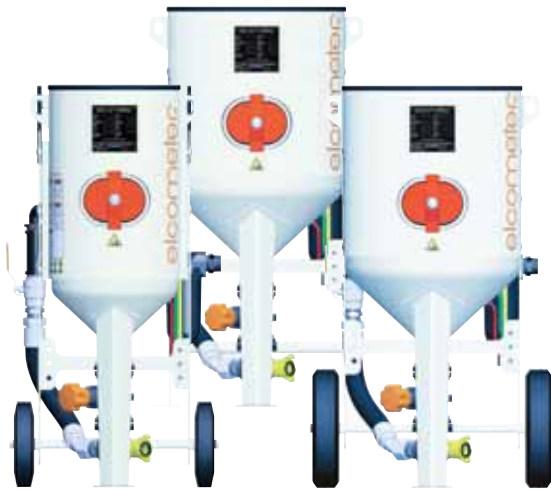

0.70-10.06cu ft (20-285 litres)

174psi (12bar)

38mm (1 1/2")

UKCA, CE & ASME Approved

Elcometer GV/AGV

elcoTOUGH™ Long Life Liner

Elcometer Engineered High Resistance  
Long Life Mixer T

Elcometer Engineered

90° Reinforced Elbow  
& Sacrificial Wear Plug

Made in Great Britain

# PERFORMANCE HP

**217psi**  
(15bar)

**1 1/2"**  
(38mm)

- Elcometer engineered valves & RCV
  - 1 1/2" (38mm) high flow pipework
  - Ultimate efficiency & productivity
    - High pressure 217psi (15bar)
  - Ideal for large scale contracts  
and long hose runs



3.53-10.06cu ft (100-285 litres)

217psi (15psi)

38mm (1 1/2")

UKCA & CE Approved

Elcometer GV/AGV

elcoTOUGH™ Long Life Liner

Elcometer Engineered High Resistance  
Long Life Mixer T

Elcometer Engineered

90° Reinforced Elbow  
& Sacrificial Wear Plug

Made in Great Britain

Elcometer **Performance**  
Abrasive Blast Machines are  
engineered to **work harder,**  
**last longer** and **perform**  
**better**



Productivity is a function of  
pressure and air flow.

*"For every psi at the nozzle above  
7bar (100psi) you get a 1.5% increase  
in productivity."*

## **ENHANCE YOUR PERFORMANCE**

Optimising the volume, speed and pressure of air to the nozzle results in greater blasting efficiency. Higher pressure and speed of air at the nozzle will also allow use of a larger nozzle size, resulting in faster blast area coverage, allowing you to cover more in less time.

Operating at more efficient blast pressures will also result in less abrasive usage thus **saving money and clean up time!**

## ■ Minimise Your Pressure Loss

The design of your blast machine together with your blast hose diameter, length, age, wear and quality can effect the pressure at the nozzle.

This is why we manufacture blast machines which have a maximum working pressure of either 174 or 217psi (12 or 15bar) and have been engineered for minimal pressure loss - so that you will always have the nozzle pressure you need to maximise your productivity.



## ■ Maximise Your Cubic Air Flow Per Minute

With an internal pipe diameter of 1½" (38mm) across our blast machines we have optimised the volumetric flow rate of air through the system every minute so that you can select a larger nozzle diameter, allowing you to blast more in less time.



## ■ Blast for Longer

Elcometer blast machines have a maximum working pressure of 174 or 217psi (12 or 15bar) allowing you to maintain the nozzle pressure over significantly longer lengths of hose, even as it wears.

## ■ Reduce Your Media Costs

Elcometer blast machines are designed to deliver the optimum pressure and flow rate at the nozzle, allowing you to use less abrasive to blast the same area to the same profile, saving you money.

Our abrasive media valves come with fingertip adjustment so that you can precisely control the media flow, even whilst blasting.



## ■ Reduce Your Maintenance

Elcometer's blast machines are engineered to be extremely durable so that parts last longer. Forcing abrasive through a high pressure system will, however, always create wear and tear so we have designed our machines to be easy and fast to maintain so that you can maximise your blast time.



## ■ Be In Control

Designed for precision control and minimal air flow loss, the Elcometer RCV4000 & RCV4000+ Remote Control Valves allow you to safely control a blast machine at the nozzle, fast.



# ELCOMETER ENGINEERED

Every aspect of an Elcometer Blast Machine uses high quality components, manufactured to an industry leading specification and designed and engineered by Elcometer experts.



## Heavy Duty Construction

1/4" (6mm) steel wall thickness, double weld seams & coated with a tough 2 pack epoxy multi-coat paint for corrosion protection.



## High Flow Pipework & Valves

Large bore 1 1/2" (38mm) pipework throughout ensures efficient airflow and minimal pressure loss.

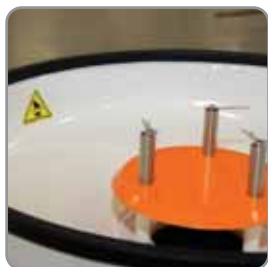

## Concave Dishes

Our high flow concave dish comes complete with a deflector plate for fast filling & operator safety.



## Fast Flow Cones

45/90° cone to maximise abrasive flow rate.



## Remote Control Valves

Used with a deadman's handle, the 1 1/2" (38mm) remote control valve minimises air flow loss and shuts the blast system down quickly and safely.



## Precision Metering Valves

Range of precision metering valves offer accurate control of your blast media, even whilst blasting.



## Exhaust Manifolds

Hard working exhaust manifolds allow air to exhaust through the silencer quickly & safely, with minimum wear.



## Moisture Separators

High performance moisture separator prevents water and oil from entering the blast pot.



### Hard-wearing Mixer T's

Machined out of a single block of high grade machine steel, the hard-wearing Elcometer Mixer T is designed to last.



### Serviceable Exhaust T's

When a blast machine exhausts, it can quickly wear out elbow joints, that is why Elcometer Exhaust T's are fitted with sacrificial wear plugs to minimise wear and maximise lifetime.

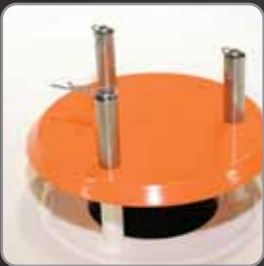

### Adjustable Deflector Plates

The adjustable height deflector plate is designed to prevent abrasive escaping the blast machine when the pop up valve is engaged - keeping you safe.



### Large Inspection Access

Large, easy to remove access doors to make maintenance easier and faster.



### Reinforced Pop Up Valves

The heavy duty internal pop up valve is long lasting and quickly responds to pressurisation.



### Narrow & Protected

Designed to fit through most standard doorways, valves and pipework are protected, even when laid down during transportation.



### Flexible Pusher Lines

Flexible pusher line ensures air flow without pressure loss caused by elbows.



### Air Manifold

The Elcometer Air Manifold allows multiple outlets for ancillary equipment and a pressure relief valve.



### Waterproof Sieves & Lids

Optional sieves & lids are designed to fit over the top of the machine to prevent water ingress, keeping the media dry.



### Balanced by Design

Easy to manoeuvre on site by one person, no matter their size.



# PERFORMANCE

Whether you are blasting at a dockyard or in a blast room, **Elcometer** offers a range of **PERFORMANCE blast machines**, from **0.7 - 10.06cu ft** (20 up to 285 litres), available with **174psi** (12bar) working pressure to maximise productivity.

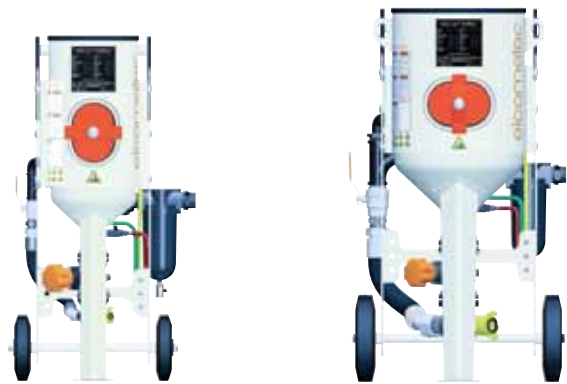

	Options	Elcometer 1020	Elcometer 1440
Capacity	Volume	0.70cu ft (20 litres)	1.41cu ft (40 litres)
	Aluminium Grit	102lbs (47kg)	206lbs (94kg)
	Steel Shot/Garnet	193lbs (88kg)	388lbs (176kg)
Valve Options	GV/MGV: General Valve/ Mini General Valve AGV: Automatic General Valve	MGV	GV AGV
Dimensions	Pot Diameter	10" (254mm)	14" (356mm)
	Height	35" (880mm)	40" (1015mm)
	Width	22" (565mm)	24" (615mm)
	Depth	22" (562mm)	28" (714mm)
	Weight	154lbs (70kg)	209lbs (95kg)





Elcometer PERFORMANCE blast machines are CE approved and fully tested and certified to ASME Boiler and Pressure Vessel Code (BPVC) Section VIII Division 1 with a maximum working pressure of 174psi (12bar).



Elcometer 1460	Elcometer 20100	Elcometer 24200	Elcometer 24285
2.11cu ft (60 litres)	3.53cu ft (100 litres)	7.06cu ft (200 litres)	10.06cu ft (285 litres)
308lbs (140kg)	515lbs (234kg)	1031lbs (468kg)	1469lbs (667kg)
580lbs (264kg)	971lbs (440kg)	1942lbs (880kg)	2767lbs (1254kg)
GV AGV	GV AGV	GV AGV	GV AGV
14" (356mm)	20" (508mm)	24" (610mm)	24" (610mm)
46" (1165mm)	46" (1175mm)	54" (1380mm)	66" (1665mm)
24" (615mm)	28" (704mm)	31" (794mm)	31" (794mm)
28" (714mm)	34" (865mm)	44" (1109mm)	44" (1109mm)
236lbs (107kg)	337lbs (153kg)	452lbs (205kg)	509lbs (231kg)

PERFORMANCE

# PERFORMANCE



Kit Selection	Elcometer 1020		Elcometer 1440			
Key Features	Ideal for touch-up applications and spot blasting. Compact, low profile size is easy to fill with abrasive.		Ideal for touch-up applications and spot blasting. Compact size with heavy duty wheels make for easy manoeuvre in small spaces.			
Elcometer Blast Machine Kits are available with:	Kit 1	Kit 2	Kit 1	Kit 2		
Part Numbers	M1020-MGV1-N	M1020-MGV2-N	M1440-GV1-N	M1440-AGV1-N	M1440-GV2-N	M1440-AGV2-N
Abrasive Blast Machine	0.70cu ft (20 litres)		1.41cu ft (40 litres)			
Pressure Test Certificate	●	●	●	●	●	●
RCV4000+ Remote Control Valve with Air Manifold, Exhaust & Silencer	●	●	●	●	●	●
Pneumatic Control Hose & Deadman's Handle (DMHII)	●	●	●	●	●	●
Choke Valve and Pusher Line	●	●	●	●	●	●
Abrasive Metering Valve with Mixer T <sup>1</sup> and Metal Pot Coupling	MG	MG	G	A	G	A
Moisture Separator	●	●	●	●	●	●
65.6ft (20m) 1¼" (32mm) ID Blast Hose with Cast Iron Hose Couplings & Nylon Nozzle Holder		● <sup>2</sup>			●	●
Externally Mounted Sieve and Lid		●			●	●

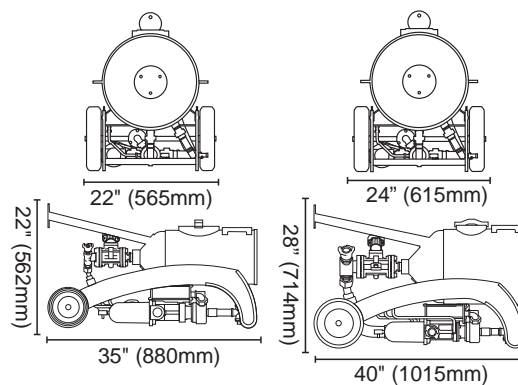

<sup>1</sup> Elcometer 1020 blast machine is supplied with a Flanged T

<sup>2</sup> Elcometer 1020 blast machine is supplied with a 10m Pneumatic Control Hose and Blast Hose



**Elcometer 1460**

**Elcometer 20100**

**Elcometer 24200**

**Elcometer 24285**

Ideal for small blast rooms and spot blasting.

Compact size with heavy duty wheels make for easy manoeuvre in small spaces.

Ideal for continuous blasting applications.

Compact size with heavy duty wheels make for easy manoeuvre in small spaces.

Ideal for mobile contractors who need continuous high production blasting as its large capacity reduces down time refilling the hopper.

The twin wheeled portable machine is safe and easy to manoeuvre.

Ideal for continuous high production blasting, on site or in a blast room.

A single blast machine can be used by one or two operators.

The twin wheeled portable machine is safe and easy to manoeuvre.

Kit 1		Kit 2		Kit 1		Kit 2		Kit 1		Kit 2		Kit 1		Kit 2	
M1460-GV1-N	M1460-AGV1-N	M1460-GV2-N	M1460-AGV2-N	M20100-GV1-N	M20100-AGV1-N	M20100-GV2-N	M20100-AGV2-N	M24200-GV1-N	M24200-AGV1-N	M24200-GV2-N	M24200-AGV2-N	M24285-GV1-N	M24285-AGV1-N	M24285-GV2-N	M24285-AGV2-N
2.11cu ft (60 litres)				3.53cu ft (100 litres)				7.06cu ft (200 litres)				10.06cu ft (285 litres)			
•	•	•	•	•	•	•	•	•	•	•	•	•	•	•	•
•	•	•	•	•	•	•	•	•	•	•	•	•	•	•	•
•	•	•	•	•	•	•	•	•	•	•	•	•	•	•	•
•	•	•	•	•	•	•	•	•	•	•	•	•	•	•	•
G	A	G	A	G	A	G	A	G	A	G	A	G	A	G	A
•	•	•	•	•	•	•	•	•	•	•	•	•	•	•	•
		•	•				•			•	•			•	•
		•	•			•	•			•	•			•	•

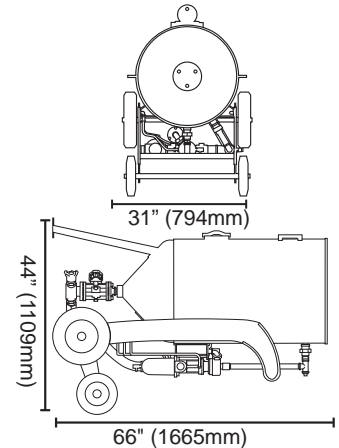
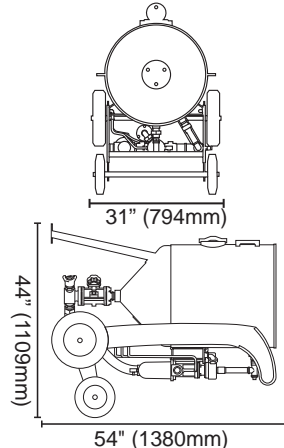
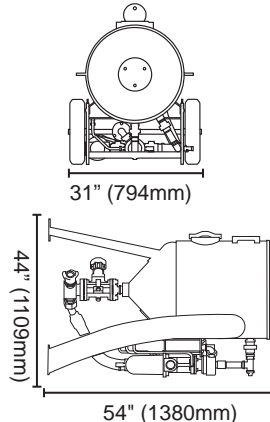
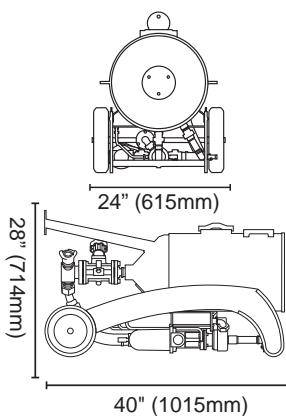

## Elcometer 20100 Portable Abrasive Blast Machine

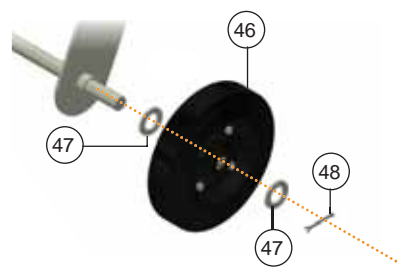
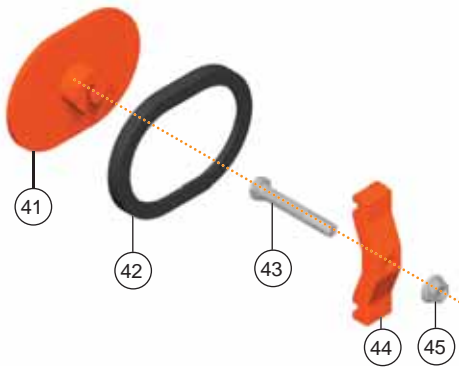
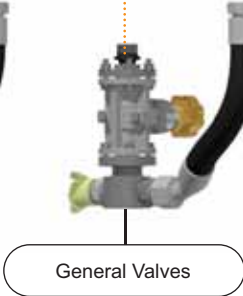
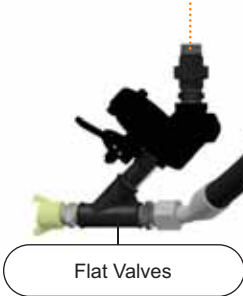
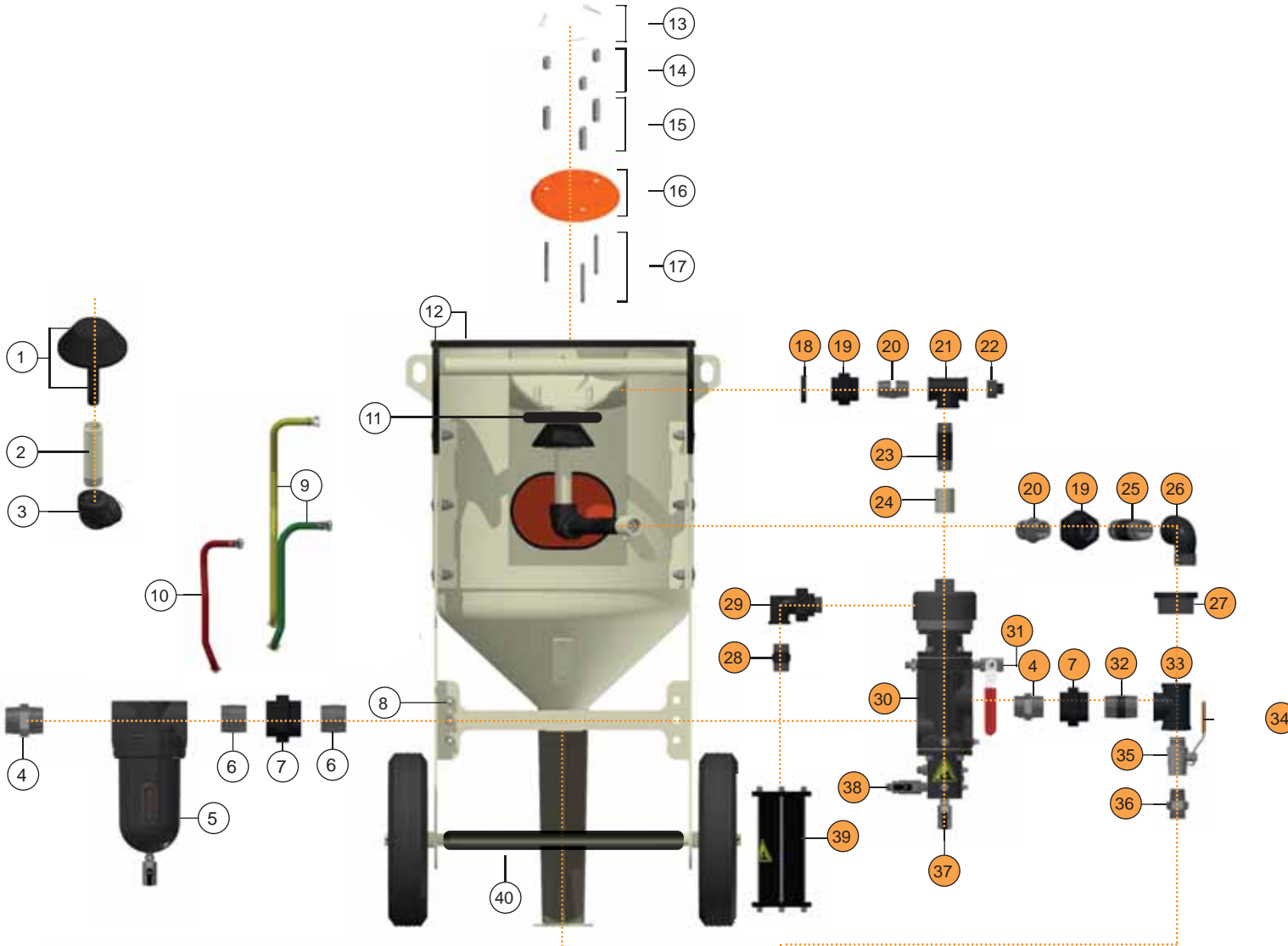



## Elcometer 20100 Portable Abrasive Blast Machine

## Spare Parts

Item	Part Number	Description
1	<b>MT28622</b>	Pop Up Valve
2	<b>MT28631-4N</b>	1" (25mm) Pop Up Shaft for Elcometer 20100
3	<b>MT29661N</b>	1" (25mm) Female 90° Equal Elbow (Service Item Only)
4	<b>MT31013-3N</b>	1½" (38mm) Hex Nipple
5	<b>MT28617N</b>	Moisture Separator Assembly
6	<b>MT30553-1N</b>	1½" (38mm) Close Nipple
7	<b>MT31018-5N</b>	1½" (38mm) Union Brass Seat
8	<b>MT29664N</b>	¼" (6mm) Bulkhead Connector (x3)
9	<b>MT29716N</b>	Elcometer 20100 Twin Airline Hose Assembly (Yellow & Green)
10	<b>MT29717N</b>	Airline Assembly for Elcometer 20100 (Red)
11	<b>MT28627-5</b>	Pop Up Valve O-Ring (x5)
12	<b>MT29601</b>	Protective Edging Strip Kit 8.9ft (2.7m)
13	<b>MT29667</b>	Spring Cotter Pin Type E (x3)
14	<b>MT29719</b>	Short Deflector Plate Spacer - 1" (25mm) (x3)
15	<b>MT29720</b>	Long Deflector Plate Spacer - 2" (51mm) (x3)
16	<b>MT29670</b>	Deflector Plate
17	<b>MT28629-3</b>	Deflector Plate Shaft - 3.2" (82mm) (x3)
18	<b>MT29672N</b>	1" (25mm) Backnut
19	<b>MT31018-3N</b>	1" (25mm) Union Brass Seat
20	<b>MT31013-2N</b>	1" (25mm) Hex Nipple
21	<b>MT30574-2N</b>	1" (25mm) Equal T
22	<b>MT29681N</b>	1" (25mm) Solid Plug
23	<b>MT30556-4N</b>	1" (25mm) SCH 40 Pipe Tube
24	<b>MT31017N</b>	1" (25mm) Machine Socket
25	<b>MT30556-5N</b>	1" (25mm) Pipe
26	<b>MT31019-2N</b>	1" (25mm) 90° Street Elbow
27	<b>MT30577-3N</b>	1½" to 1" (38mm to 25mm) Reducing Bush
28	<b>MT31013-1N</b>	¾" (19mm) Hex Nipple
29	<b>MT28599N</b>	¾" (19mm) Union Elbow Male
30	<b>MT29465N</b>	Elcometer RCV4000+ Remote Control Valve
31	<b>MT29656N</b>	Petcock Valve Assembly (Red Handle)
32	<b>MT30556-2N</b>	1½" (38mm) Pipe
33	<b>MT29708N</b>	1½" (38mm) Equal Pitcher T
34	<b>MT30094N</b>	1½" (38mm) Choke Valve Handle
35	<b>MT29177N</b>	1½" (38mm) Choke Valve Handle (includes MT30094N Choke Valve Handle)
36	<b>MT29710N</b>	1½" (38mm) NPTF Male x ⅞" JIC Male Adaptor
37	<b>MT29658N</b>	¼" (6mm) Ball Valve Assembly (Black Handle)
38	<b>MT29660N</b>	¼" (6mm) Airline Ball Valve Assembly (Black Handle)
39	<b>MT28597N</b>	Exhaust Silencer Assembly
40	<b>MT29692-3</b>	Protection Guard for Elcometer 20100
41	<b>MT28616</b>	Elcometer Inspection Hatch Door for Elcometer 20100
42	<b>MT28613</b>	ElcoFit™ Door Sealing Gasket
43	<b>MT29695N</b>	Elcometer Inspection Door Hatch Bolt - ⅝" x 4⅓" (M16 x 110mm)
44	<b>MT28615</b>	Inspection Hatch Door Yoke
45	<b>MT29696N</b>	⅝" (M16) Hexagon Flanged Nut
46	<b>MT28637</b>	Ø13.8" (350mm) Diameter Wheel (x1)
47	<b>MT29697</b>	Flat Washer (x8)
48	<b>MT29698</b>	Split Cotter Pin (x4)
-	<b>MT29490-4N</b>	Elcometer RCV4000+ & Pipework Assembly Service Kit (contains items in orange)
-	<b>MT29180</b>	Elcometer Safety Label Kit